



Technische Merkmale

- Max. 30 Amp. Schleifringbelastung
- Offene stabile Alu-Druckgussausführung
- Ausführung ohne Leitung/ Querschnitt und Länge nach Wahl
- Die Abzugslänge ist abhängig vom Leitungsdurchmesser
Unsere Techniker beraten Sie gerne
- Mit Raste, Oesenjoch und Kabelstopper
- Starrer Montagehalter
- Auf Wunsch mit CEE-Steckeinheiten 16 A / 32 A
- Fertig montiert, ausgeführtes Leitungsende 2 m, bei 5 x 2.5 mm² Bestückung

Massbild Ansicht





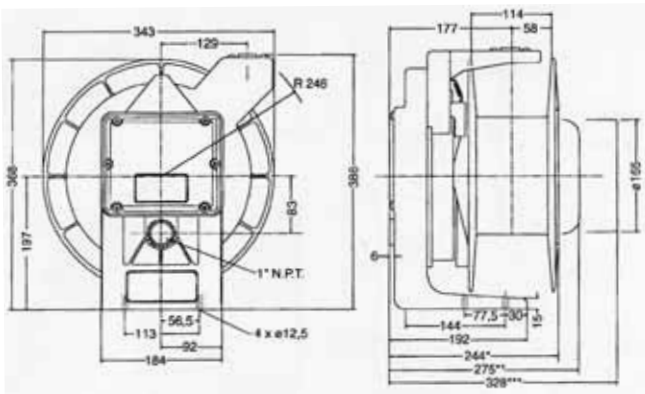

*5-polig = 244 mm

**8-polig = 275 mm

***12-polig = 328 mm



Stabile 4-fach Rollenführung

Typ	Artikel-Nr.	Pol	Querschnitt	Länge	Max. Belastung	Leitung			Preis*
 MIBAG 5-30	003000-5-30	5	2.5 mm ²	15 m	max. 30A	G-PUR	IP54	18 kg	1'295.00
 MIBAG 5-30-1	003000-5-30-1	5	2.5 mm ²	15 m	max. 30A	Trommelflex PUR	IP54	19 kg	1'395.00
 MIBAG 5-30-2	003000-5-30-2	5	4 mm ²	12 m	max. 30A	Trommelflex PUR	IP54	20 kg	1'430.00
 MIBAG 5-30-o	003000-5-30-o	5	-	-	max. 30A	ohne	IP54	15 kg	1'195.00
MIBAG 8-30-o	003000-8-30-o	8	-	-	max. 30A	ohne	IP54	17 kg	1'325.00
MIBAG 12-30-o	003000-12-30-o	12	-	-	max. 30A	ohne	IP54	19 kg	1'375.00



*Preise in CHF exkl. MWST / ab Samstagern

 Lagerführend, ZV vorbehalten

2-15