



Einfache Montage

Technische Merkmale







- Geeignet für Industrieinsatz mit hohen Leistungsangaben
- Kabel-Aufrollautomatik mit Federantrieb
- Gehäuse aus schlagfestem Kunststoff
- Kompakte Bauweise, ideal bei geringen Platzverhältnissen
- Mit oder ohne Arretierung erhältlich („A“ in Artikel = mit)
- Konform nach CE-Normen
- Sicherungsanschlussklemmen mit Glaskolbensicherung 10A
- Auf Wunsch können die Aufroller mit PUR, Gummi oder Leitungen Ihrer Wahl bestückt werden.



Anschlussklemmen mit Feinstsicherungseinsatz



Schleifringkörper mit extrem hoher Leistung für Industrie

Typ	Arretierung	Artikel-Nr.	Polzahl	Querschnitt	Länge			Leitung			Preis*
 EFT 130A.3KK3075	✓	003430001	3	0.75 mm ²	3 m	1'000 W	2'300 W	PVC	0.8kg	IP 20	149.00
 EFT 130.3KK3075	X	003403030	3	0.75 mm ²	3 m	1'000 W	2'300 W	PVC	0.8kg	IP 20	146.00
 EFT 160A.5KK3075	✓	003413051	3	0.75 mm ²	5 m	1'000 W	2'300 W	PVC	0.9kg	IP 20	165.00
EFT 160.5KK3075	X	003403050	3	0.75 mm ²	5 m	1'000 W	2'300 W	PVC	1.1kg	IP 20	161.00
 EFT 265A.0308	✓	003413081	3	1.5 mm ²	8 m	1'800 W	2'300 W	PVC	2.3kg	IP 20	307.00
 EFT 265.0308	X	003403080	3	1.5 mm ²	8 m	1'800 W	2'300 W	PVC	2.9kg	IP 20	299.00
 EFT 265A.0505	✓	003415051	5	1.5 mm ²	5 m	2'200 W	6'800 W	PVC	2.3kg	IP 20	389.00
EFT 265.0505	X	003405050	5	1.5 mm ²	5 m	2'200 W	6'800 W	PVC	3.1kg	IP 20	369.00

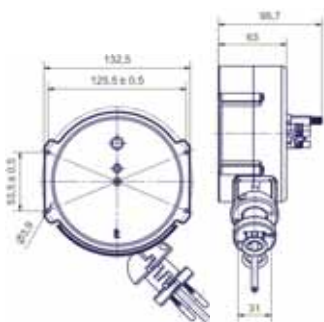

EFT 130

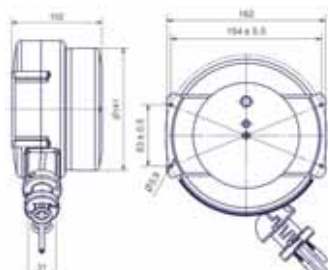

EFT 160

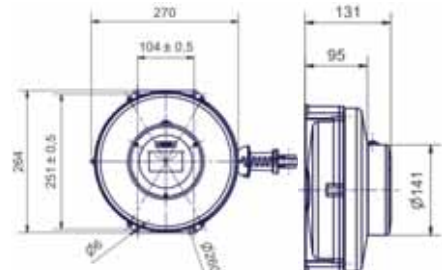

EFT 265

*Preise in CHF exkl. MWST / ab Samstagern

 Lagerführend, ZV vorbehalten

2-16