















Fix montiert



Zubehör: Inox AISI 304 Schwenkpl.

Schläuche	Anschlüsse	Dichtung	Drehgelenk	Achse
ohne	ohne	Viton®	Edelstahl AISI 304	Edelstahl AISI 304
				



Schlauchaufroller		Schwenkplatte		Länge	Schlauch Ø	innen	aussen
8392.200	CHF 579.00 	843006	CHF 97.00 	ohne		F1/2"G	F3/8"-1/2"G
8434.200	CHF 786.00 	843006	CHF 97.00 	ohne		F1/2"G	F1/2"G
8434.250	CHF 919.00 	843006	CHF 97.00 	ohne		F1"G	F3/4"G
8534.200	CHF 1'069.00 	853006	CHF 111.00 	ohne		F1/2"G	F1/2"G
8534.250	CHF 1'159.00 	853006	CHF 111.00 	ohne		F1"G	F1"G
8544.200	CHF 1'198.00 	854006	CHF 287.00 	ohne		F1"G	F1"G
8544.205	CHF 1'123.00 	854006	CHF 287.00 	ohne		F1/2"G	F1/2"G

In Übereinstimmung
mit Richtlinie II 2 GD

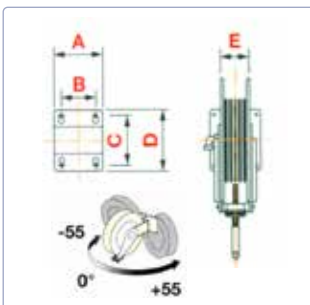

Abmessungen Schwenkbare Ausführung

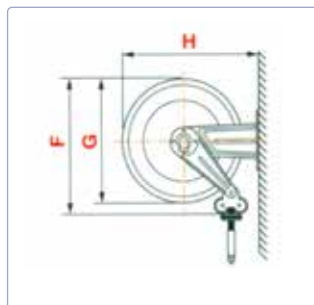

Art.	A	B	C	D	E	F	G	H	I
S. 390	208	162	118	165	110	355	350	459	20
S. 430	208	162	118	165	110	400	390	504	20
S. 530	208	162	118	165	115	460	420	554	20
S. 540	208	162	118	165	115	550	510	654	20