

















Monté fixe



Accessoires: Plaque pivotante inoxydable AISI 304

Tuyaux	Raccords	Joint	Charnière	Axe
sans	sans	Viton®	Inox AISI 304	Inox AISI 304
				



Enrouleur de tuyau		Plaque pivotante		Longueur	Tuyau Ø	Int.	Ext.
8392.200	CHF 579.00 	843006	CHF 97.00 	sans		F1/2"G	F3/8"-1/2"G
8434.200	CHF 786.00 	843006	CHF 97.00 	sans		F1/2"G	F1/2"G
8434.250	CHF 919.00 	843006	CHF 97.00 	sans		F1"G	F3/4"G
8534.200	CHF 1'069.00 	853006	CHF 111.00 	sans		F1/2"G	F1/2"G
8534.250	CHF 1'159.00 	853006	CHF 111.00 	sans		F1"G	F1"G
8544.200	CHF 1'198.00 	854006	CHF 287.00 	sans		F1"G	F1"G
8544.205	CHF 1'123.00 	854006	CHF 287.00 	sans		F1/2"G	F1/2"G

Conforme à la directive II 2 GD

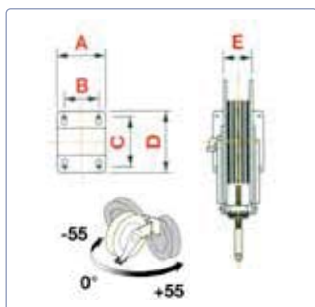

Dimensions version pivotante

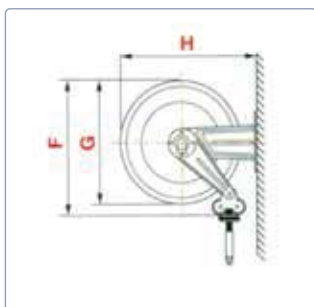

Art.	A	B	C	D	E	F	G	H	I
S. 390	208	162	118	165	110	355	350	459	20
S. 430	208	162	118	165	110	400	390	504	20
S. 530	208	162	118	165	115	460	420	554	20
S. 540	208	162	118	165	115	550	510	654	20