





















Version massive VA avec manivelle manuelle

Frein mécanique, utilisable pour l'eau, pour pression maxi 100 ou 200 bar, sans tuyau (sur demande)

Applications: station d'épuration, gravière, centrale électrique, agriculture etc.

Type	Poids	Longueur de tuyau enroulable	Tuyau Ø	Pression maxi bar	Dimensions en mm						*CHF
					Filetage	A	B	C	D	Matériau de la charnière	
STKi2 20/12	10.5	35 m	22 mm	200	12 = 1/2"i	280	312	200	414	A1/V2a	615.00 
STKi2 20/19	11.7	20 m	28 mm	200	19 = 3/4"i	280	312	200	414	Ms/V2a	795.00 
STKi2 20/24	12.0	15 m	35 mm	100	24 = 1"i	280	312	200	414	Ms/V2a	915.00 
STKi2 40/12	13.5	70 m	22 mm	200	12 = 1/2"i	480	512	400	614	A1/V2a	655.00 
STKi2 40/19	14.7	40 m	28 mm	200	19 = 3/4"i	480	512	400	614	Ms/V2a	845.00 
STKi2 40/24	15.0	33 m	35 mm	100	24 = 1"i	480	512	400	614	Ms/V2a	945.00 
STKi2 50/12	14.6	85 m	22 mm	200	12 = 1/2"i	580	612	500	714	A1/V2a	789.00 
STKi2 50/19	15.8	50 m	28 mm	200	19 = 3/4"i	580	612	500	714	Ms/V2a	932.00 
STKi2 50/24	16.1	43 m	35 mm	100	24 = 1"i	580	612	500	714	Ms/V2a	1'090.00 
STKi2 60/12	15.7	100 m	22 mm	200	12 = 1/2"i	680	712	600	814	A1/V2a	905.00 
STKi2 60/19	16.9	60 m	28 mm	200	19 = 3/4"i	680	712	600	814	Ms/V2a	1'095.00 
STKi2 60/24	17.2	52 m	35 mm	100	24 = 1"i	680	712	600	814	Ms/V2a	1'205.00 
STKi2 70/12	16.8	115 m	22 mm	200	12 = 1/2"i	780	812	700	914	A1/V2a	1'165.00 
STKi2 70/19	18.0	70 m	28 mm	200	19 = 3/4"i	780	812	700	914	Ms/V2a	1'335.00 
STKi2 70/24	18.3	61 m	35 mm	100	24 = 1"i	780	812	700	914	Ms/V2a	1'429.00 
STKi2 80/12	17.9	130 m	22 mm	200	12 = 1/2"i	880	912	800	1014	A1/V2a	1'285.00 
STKi2 80/19	19.1	80 m	28 mm	200	19 = 3/4"i	880	912	800	1014	Ms/V2a	1'475.00 
STKi2 80/24	19.4	70 m	35 mm	100	24 = 1"i	880	912	800	1014	Ms/V2a	1'575.00 

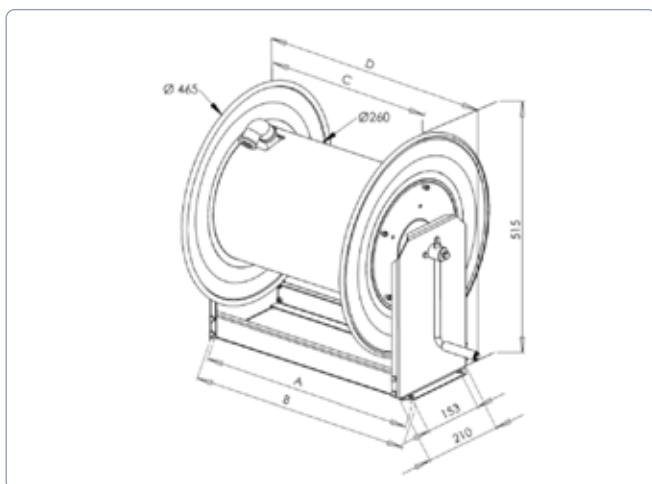

Levier de blocage



Vue de la valve rotative

*Prix hors TVA • Livraison à partir de Samstagen